

General Accessories

IP69K Connector Cables

Type CONB1...W

CARLO GAVAZZI

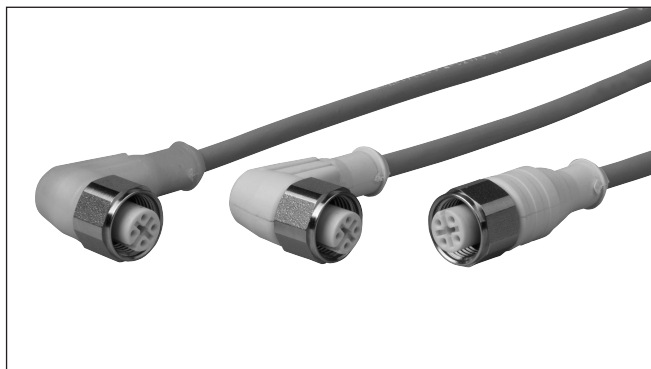

- IP69K version
- Straight or 90° connector
- M12 version
- 4-wire
- Good resistance against chemicals
- High temperature - up to 105°C (UL 90°C)
- UL and ECOLAB approved
- LED version also available

Product Description

Highly robust IP69K connection cables for harsh environments. Especially suitable for use in washdown industries such as food & beverage, chemical and pharmaceutical industries thanks to the high standards of UL and ECOLAB. Featuring UL certified temperatures of up to 90°C, ECOLAB certification and IP69K protection class, the CONB IP69K connectors offer a guaranteed long term reliability even in the

harshes environments. Moreover, the connectors are resistant to aggressive chemicals and cleaning agents adhering to high Ecolab standards which make them very suitable to be used in Food & Beverage industry.

For maximum flexibility, the connectors are available in straight or angled versions as well as with or without LED in M12 connector, 4 wires.

Ordering Key

CONB14NF-AP2W

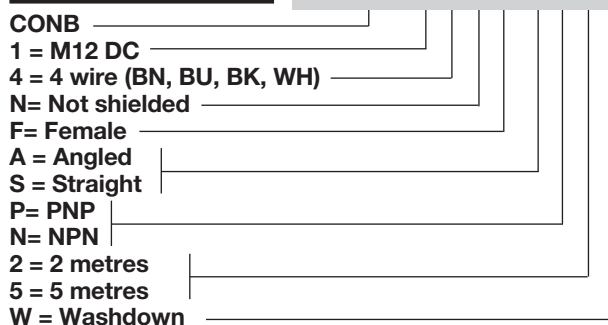

Type Selection

Plug type	Cable length	Ordering number PVC	Ordering number
			PVC LED PNP
4-Wire Angled	2 m	CONB14NF-A2W	CONB14NF-AP2W
	5 m	CONB14NF-A5W	CONB14NF-AP5W
4-Wire Straight	2 m	CONB14NF-S2W	CONB14NF-SP2W
	5 m	CONB14NF-S5W	CONB14NF-SP5W

Specifications

Rated operating voltage (U_B) LED versions	250 V ac/dc (30V UL) 30 VDC	Connection cable	TPE orange
Output current	≤ 4 A	Wire cross section	4 x 0.25 mm ² (jacket Ø 4.7 mm)
Contact resistance	≤ 5 mΩ	Weight 2 m version 5 m version	approx 63 g approx 109 g
Contact material Coating	Cu/Sn Cu/Au	Pollution degree	3
Contact bearer material	PP white	Overvoltage category	III
Temperature	-40° to +105°C (90°C UL) -40° to +221°F (194°F UL)	Insulation group	I
Degree of protection	IP69K	LED colour* Power Output CONB14NF-AP.W CONB14NF-SP.W	Green LED 2 Yellow LED 1 Yellow LED only
O-ring sealing	EPDM		
Rated Impulse Voltage Insulation resistance	2.5 kV > 10 ⁹ Ohm		
Moulded body material	PP white		
Union Locking nut	V4A		

* Please refer to wiring diagram section



Dimensions

Straight Version

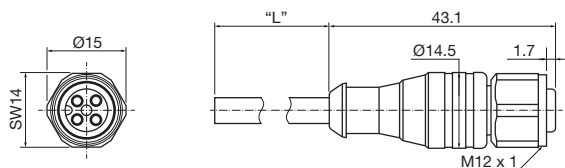

Angled Version

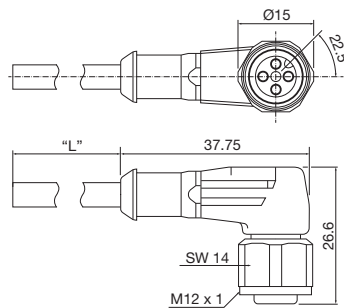

LED Straight Version

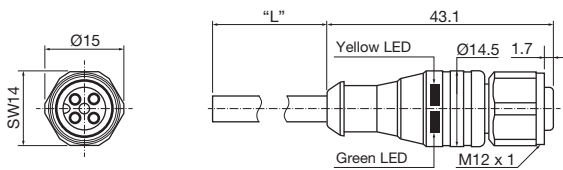

LED Angled Version

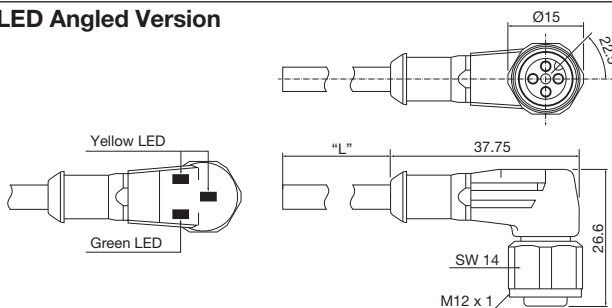

Contact layout

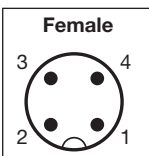

Colour Code

- 1 Brown
- 2 White
- 3 Blue
- 4 Black

Wiring Diagram

CONB14NF-AP_W

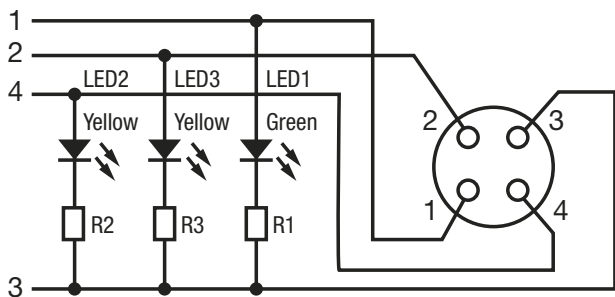

CONB14NF-SP_W

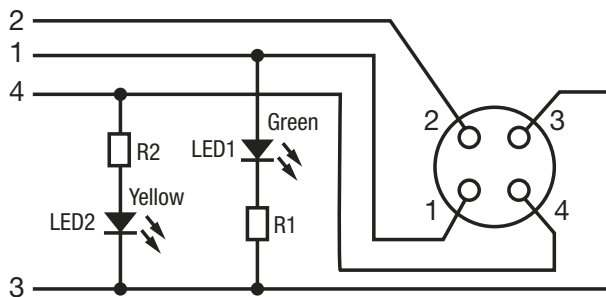



Derating Curve (DIN EN 60512-5-2)

